

DUALTORN TOGO

*En raison de la nature du produit, les retours en boîte ouverte ne sont pas acceptés.

MANUAL D'UTILISATION

Veillez lire le manuel d'utilisation en entier avant d'opérer.

Ne laissez pas les autres utilisateurs utiliser la trottinette sans avoir lu le manuel.

*** Cette trottinette est très puissante, vous pourriez être en danger si vous ne l'utilisez pas conformément aux lignes directrices énoncées dans ce manuel.**

NOTICE ORIGINALE

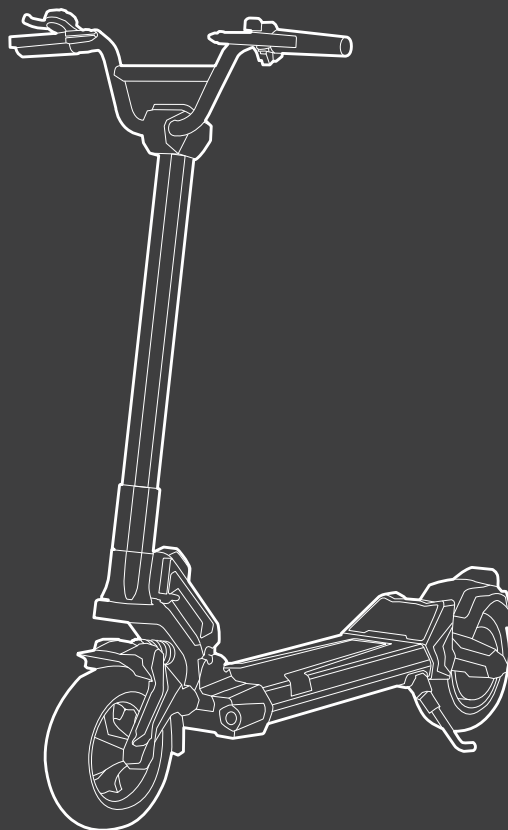

Model No. : AD2309



Scanner le QR code pour télécharger la
dernière version du manuel d'utilisation et
obtenir les dernières mises à jour et consignes de
sécurité

DUALTRON

Le rêve de la technologie électrique

Les images figurées dans ce manuel sont non contractuelles.

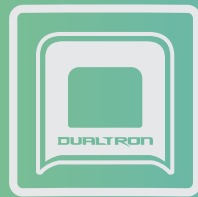

MINIMOTORS



Présentation

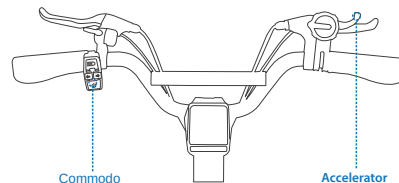
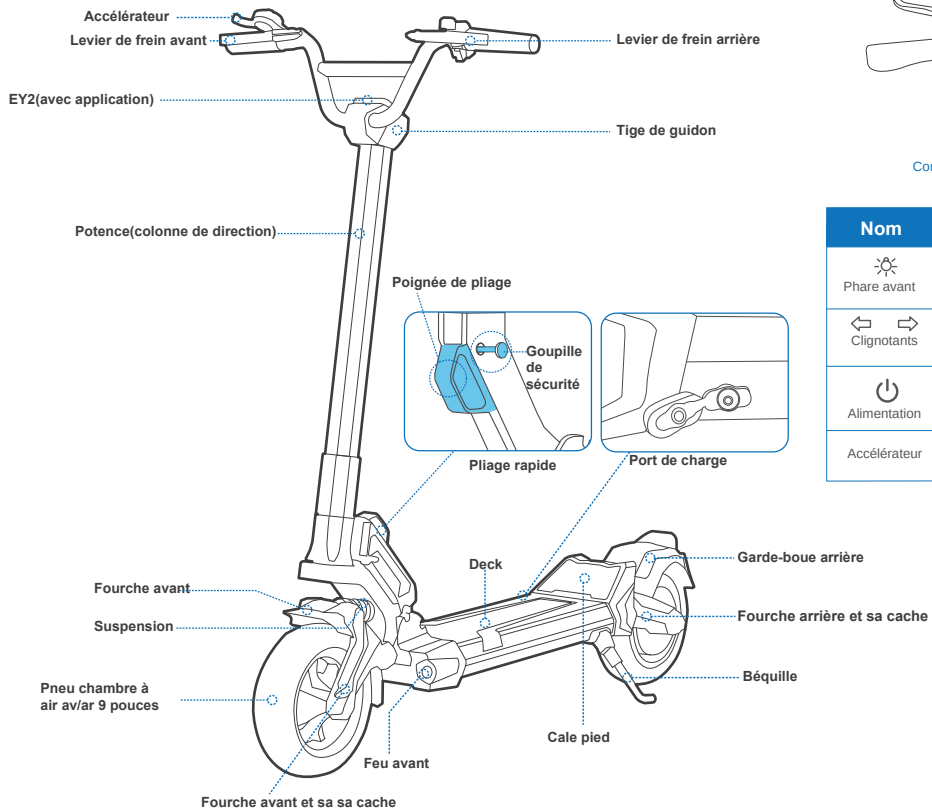

Nom	Fonction	Méthode d'opération
 Phare avant	Allumer/éteindre	Appuez sur le bouton, le phare s'allume . Appuez de nouveau et le phare s'éteint.
 Clignotants	Allumer/éteindre	Appuez sur le bouton droit/gauche, le clignotant droit/gauche s'allume .
 Alimentation	Allumer/éteindre	Appuez et maintenez enfoncé le bouton pour allumer/éteindre la trottinette.
Accélérateur	Accélérer	Appuez sur la gâchette pour accélérer



Caractéristiques

Produit	Élément	Paramètre				
Batterie	Modèle	Dualtron Togo			Dualtron Togo Plus	
	Batterie	36V7.8Ah	36V12Ah	36V15Ah (Samsung)	48V12Ah	48V15Ah (Samsung)
	Autonomie	20km	30km	40km	40km	50km
	Température de charge	0 à 40°C (Lorsque la température de la batterie est supérieure à 55 °C, le programme de protection de batterie s'active)				
	Système de gestion batterie BMS	Protection contre la surchauffe, les courts-circuits, les surintensités, les décharges excessives et les surcharges				
Utilisateur	Charge max.	100kg				
	Âge recommandé	14-60 ans selon la loi				
Afficheur	Type	Afficheur EY2 (Application DUALTRON disponible)				
Moteur	Type Moteur	Moteur Hub BLDC				
	Puissance nominale	420W			650W	
Trottinette	Poids net	Environ 22.8kg	Environ 23.5kg	Environ 23.7kg	Environ 24.3kg	Environ 24.4kg
	Pente max.	Environ 26.8% [15°]				
	Système de conduite	Mono moteur				
	Vitesse	25km/h				
	Longueur × Largeur × Hauteur (déplié)	1200×600×1130mm				
	Longueur × Largeur × Hauteur (plié)	1160×600×400mm				
	Empattement	Environ 940mm				
	Garde au sol	90mm				
	Terrain adapté	Asphalte/chaussée plate ; obstacles < 5 cm; fossé < 5 cm				
	Température d'utilisation	-5 à 45°C				
Température de stockage	-20 à 50°C					



Caractéristiques

Frein	Type	Double frein à tambour	
	Frein électrique	ABS&EBS (Indiquant que la température de la batterie dépasse 55 ° C, le programme de protection de démarrage BMS échoue.)	
Chargeur	Tension d'entrée	100-120V/200-240V~	
	Max. Output Voltage	36V: 41.5V1.5A	48V: 54V1.5A
Pneu	Type	Pneu 9 pouces 70/50-6.1	
	Pression pneu	50PSI	
	Matériau	Caoutchouc	
Suspension	Type	Ressort et suspension en caoutchouc avant et arrière	

****Avertissement :** il ne s'agit pas d'un avis juridique ou d'un conseil juridique. Les renseignements fournis dans le présent document (y compris dans l'application) sont fournis à des fins de commodité et d'information seulement. Il n'est pas destiné à conformer toutes les lois et/ou réglementations qui peuvent être applicables à ce produit. DUALTRON décline explicitement par les présentes toute garantie, expresse ou implicite, relative à la complétude, l'exactitude et la mise à jour de ces informations. DUALTRON se réserve le droit mais n'est pas dans l'obligation de corriger, mettre en oeuvre et/ou mettre à jour les informations. Vous utiliserez les informations à vos propres risques. Il est de votre seule responsabilité d'apprendre et de comprendre toutes les lois et / ou règlements, exigences, interdiction, restriction et / ou limitation imposée par la loi, l'autorité gouvernementale, le tribunal, ou les autres parties qui peuvent s'appliquer à l'utilisation de ce produit.

****Autonomie théorique :** Mise à l'essai avec batterie pleine, charge de 75 kg, 25 °C, à une vitesse de 25 km/h en moyenne sur chaussée.

****Autonomie typique :** Mise à l'essai avec batterie pleine, charge de 75 kg, 25 °C, à une vitesse de 50 km/h en moyenne sur chaussée. (Certains des facteurs qui influent sur la l'autonomie comprennent la vitesse, le nombre de démarrages et d'arrêts, la température ambiante, etc.)

Vitesse maximale : mise à l'essai avec une batterie pleine, charge de 75 kg, 25 °C, route droite sur route plate sans vent. (Certains facteurs environnementaux peuvent avoir une incidence sur la vitesse maximale, les routes inégales, les routes tortueuses, la température, le vent, etc.)



Contenu du carton

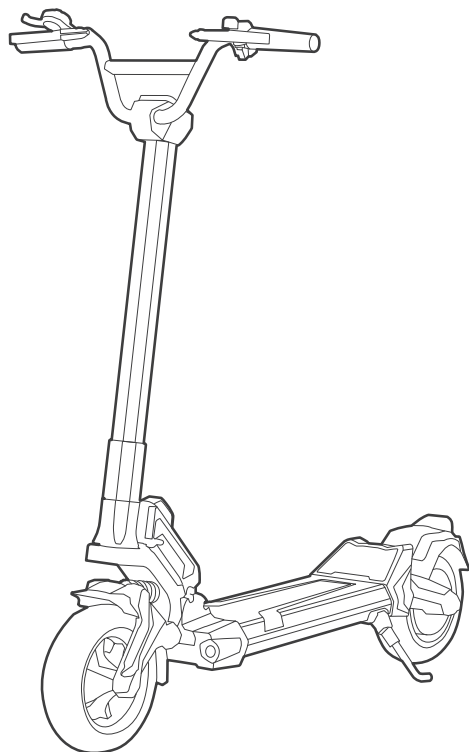

Accessoires



Chargeur x1

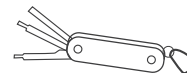

Outil x 1



Manuel

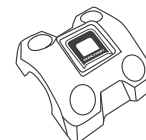

Fixation guidon

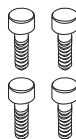

4 vis



Montage

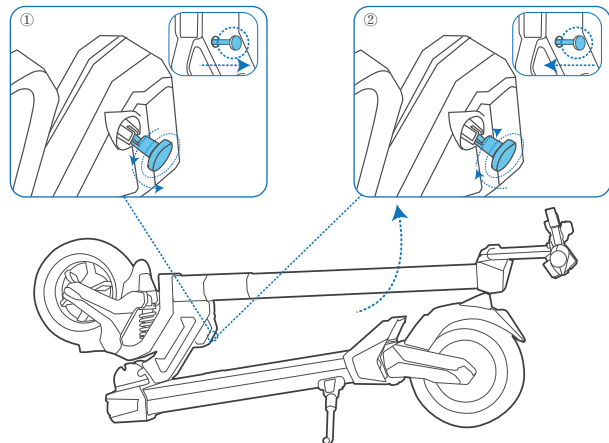

1. Poussez la goupille de sécurité vers l'extérieur et tournez-la légèrement pour assurer une fixation en sécurité, la goupille de sécurité sera bloquée et la poignée de pliage fonctionnera.
2. Soulevez la potence et réinsérez la goupille de sécurité pour rendre le système de pliage plus sécurisé.

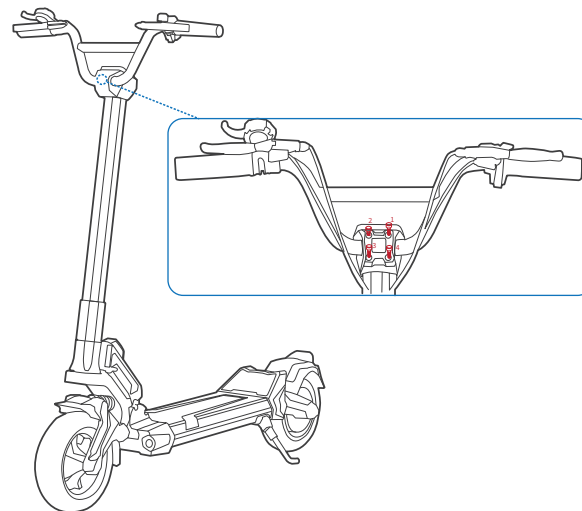

3. Fixez le guidon et serrez les 4 vis. Lors du serrage de vis, le premier serrage est à 90%, serrez les 4 vis selon l'ordre 1-3-2-4 comme montré dans l'image, le second serrage est à 100%.

Connexion Bluetooth

Guide de téléchargement APP

Méthode 1

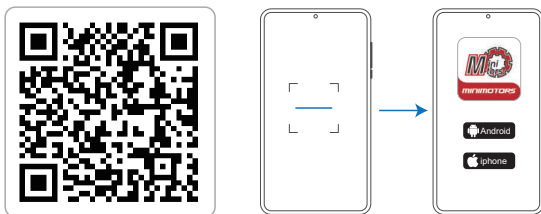

1. Scannez le QR code pour télécharger l'application.
2. Choisissez le système de téléphonie mobile et enregistrez-vous / connectez-vous.

Méthode 2

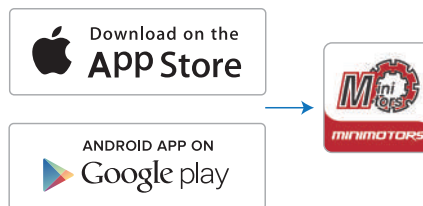

1. Recherchez "DUALTRON" dans l'application et téléchargez-la, puis enregistrez-vous / connectez-vous

Appairer le Bluetooth sur l'APP

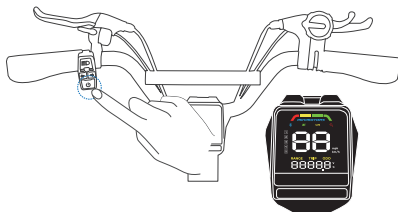

Allumez la trottinette

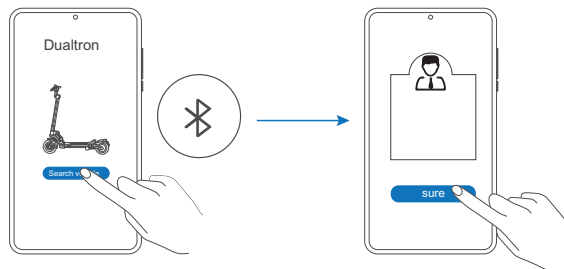

Cliquez sur "Rechercher un véhicule" et appairez avec votre trottinette. * La trottinette est connectée à l'application Dualtron lorsque le symbole Bluetooth s'allume.

Sélectionnez-la et enregistrez-vous en tant que propriétaire (Personne d'autre ne peut se connecter, seules les personnes autorisées par vous sont autorisées à se connecter. Les autorisations sont créées sur l'application.)



Comment utiliser la trottinette

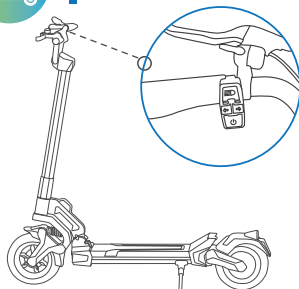

1. Allumez la trottinette et choisissez le mode de vitesse. * Veuillez choisir le mode de vitesse avant de rouler !
Remarque : le mode vitesse peut être choisi via l'application Dualtron.



2. Tenez-vous sur le marchepied avec un pied et poussez avec l'autre pied pour commencer à glisser. * Assurez-vous d'avoir désactivé le mode SAFE. (Réglage du mode SAFE via l'application Dualtron. Désactivez le mode SAFE en appuyant sur le levier de frein.)

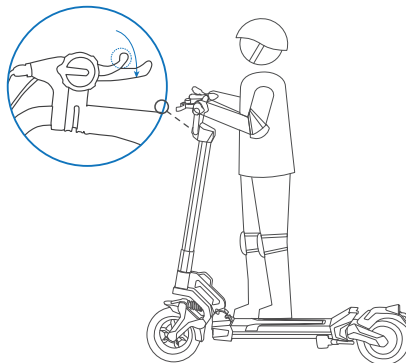

3. Mettez les deux pieds sur le marchepied et tenez-vous stable. Appuyez sur l'accélérateur pour accélérer.

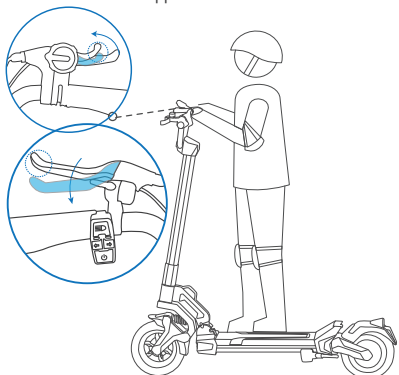

4. Ralentissez en relâchant l'accélérateur et en serrant les leviers de frein.

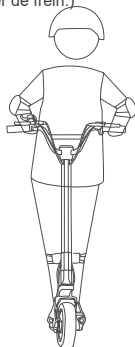

5. Pour tourner, déplacez votre corps et tournez le guidon légèrement. Veuillez faire attention aux conditions routières, un espace de virage suffisant est nécessaire.

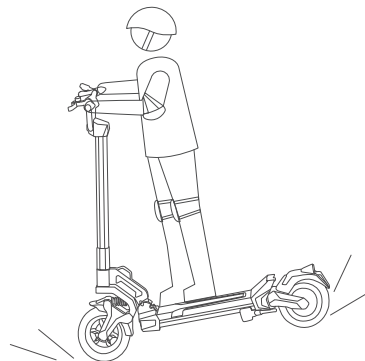

En cas de freinage brusque, un danger grave ou des blessures peuvent survenir. Maintenez une vitesse modérée et faites attention aux dangers potentiels.



Pliage

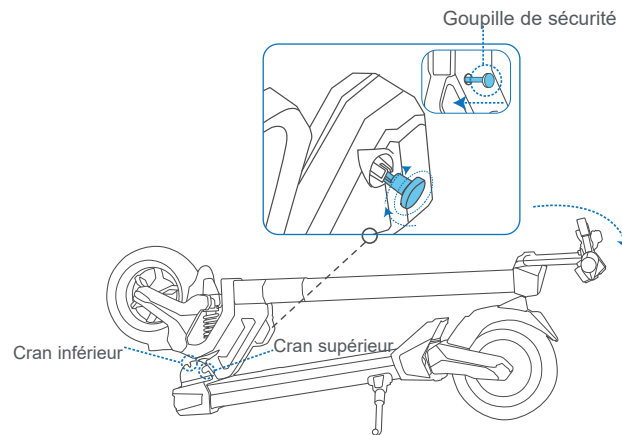
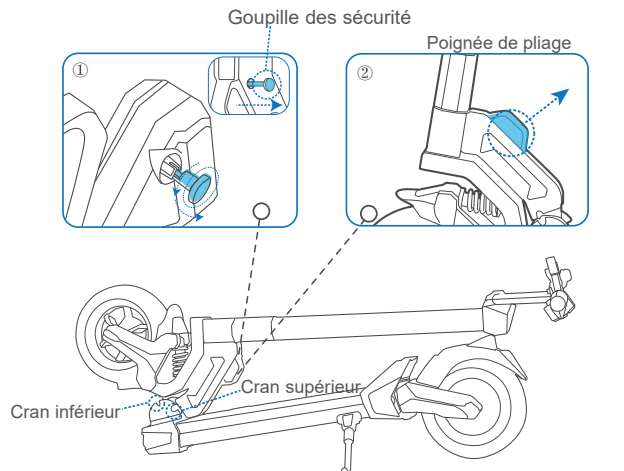

1. Poussez la goupille de sécurité vers l'extérieur et tournez-la légèrement pour assurer une fixation en sécurité, la goupille de sécurité sera bloquée et la poignée de pliage fonctionnera.
2. Tirez la poignée de pliage, le piston pliant sortira du cran supérieur et glissera vers le cran inférieur.

Lorsque le piston pliable se bloque dans le cran inférieur, n'oubliez pas d'insérer la goupille pour fixer le système de pliage.

DUALTORN TOGO

***Debido a la naturaleza del producto, no se aceptarán devoluciones de cajas ya abiertas.**

MANUAL DEL USUARIO

Lea todo el manual de usuario antes de utilizar el aparato.

No permita que otros usuarios utilicen el patinete eléctrico sin haber leído el manual.

*** Este patinete eléctrico es muy potente, podría correr riesgos si no lo utiliza de acuerdo con las directrices de este manual.**

MANUAL ORIGINAL

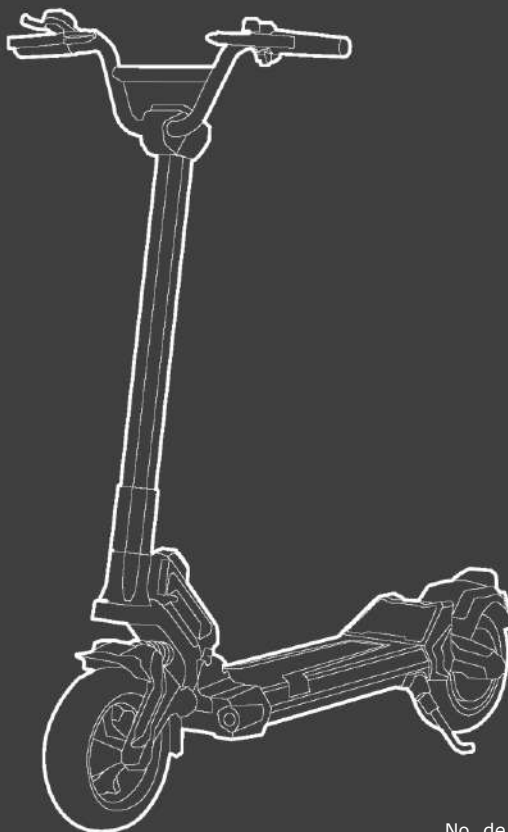

No. de modelo: AD2309



Escanee el código QR para descargar la más reciente versión del manual del usuario y obtener las más recientes actualizaciones e instrucciones de seguridad.

DUALTRON

El sueño de la tecnología eléctrica

Las imágenes de este manual no tienen carácter contractual.





MINIMOTORS

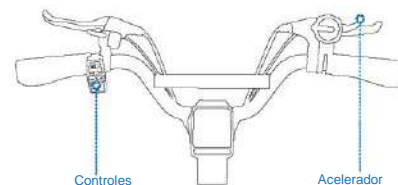
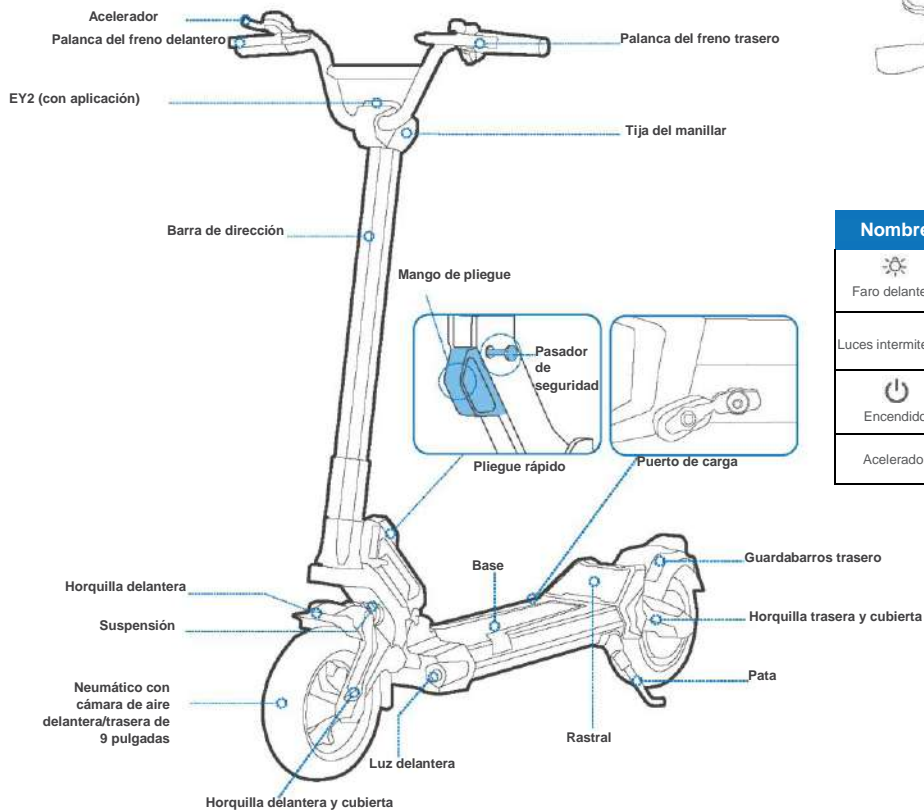

Presentación



Nombre	Función	Método de uso
 Faro delantero	Encender/ Apagar	Pulse el botón del faro y el faro se encenderá. Púlselo de nuevo y el faro se apagará.
Luces intermitentes	Encender/ Apagar	Pulse el botón derecha/izquierda y la luz intermitente derecha/izquierda se iluminará.
 Encendido	Encender/ Apagar	Mantenga pulsado el botón para encender/apagar el patinete eléctrico.
Acelerador	Acelerar	Apriete el gatillo para acelerar.



Características

Elemento		Parámetro				
Producto	Modelo	Dualtron Togo			Dualtron Togo Plus	
Batería	Batería	36 V 7,8 Ah	36 V 12 Ah	36 V 15 Ah (Samsung)	48 V 12 Ah	36 V 15 Ah (Samsung)
	Autonomía	20 Km	30 Km	40 Km	40 Km	50 Km
	Temperatura de carga	De 0 a 40°C (cuando la temperatura de la batería sea superior a 55°C, se activará el programa de protección de la batería)				
	Sistema de gestión de la batería	Protección contra sobrecalentamiento, cortocircuito, sobrecorriente, sobredescarga y sobrecarga				
Usuario	Peso máximo	100 Kg				
	Edad recomendada	14-60 años, en cumplimiento con la ley				
Pantalla	Tipo	Pantalla EY2 (aplicación DUALTRON disponible)				
Motor	Tipo de motor	Motor Hub BLDC				
	Potencia nominal	420 W			650 W	
Patinete eléctrico	Peso neto	22,8 Kg aprox.	23,5 Kg aprox.	23,7 Kg aprox.	24,3 Kg aprox.	24,4 Kg aprox.
	Pendiente máxima	26,8% (15°) aprox.				
	Sistema de tracción	Motor individual				
	Velocidad	25 Km/h				
	Longitud x Anchura x Altura (desplegado)	1200 x 600 x 1130 mm				
	Longitud x Anchura x Altura (plegado)	1160 x 600 x 400 mm				
	Distancia entre los ejes	940 mm aprox.				
	Altura sobre el suelo	90 mm				
	Terreno apropiado	Carretera asfaltada/plana; obstáculos < 5 cm; zanjas < 5 cm				
	Temperatura de funcionamiento	De -5 a 45°C				
	Temperatura de almacenamiento	De -20 a 50°C				



Características

Freno	Tipo	Freno de tambor doble	
	Freno eléctrico	ABS y EBS (Si la temperatura de la batería supera los 55°C, el programa de protección de arranque BMS no permitirá el arranque).	
Cargador	Voltaje de entrada	100-120 V/200-240 V~	
	Voltaje de salida máximo	36 V: 41,5 V 1,5 A	48 V: 54 V 1,5 A
Neumático	Tipo	Neumático de 9 pulgadas 70/50-6.1	
	Presión de los neumáticos	50 PSI	
	Material	Caucho	
Suspensión	Tipo	Suspensión y muelles de goma delanteros y traseros	

**Descargo de responsabilidad: Esta no es una opinión legal ni constituye asesoramiento jurídico. La información facilitada en este documento (incluyendo la aplicación) tiene únicamente fines prácticos e informativos. No pretende conformarse a todas las leyes y/o normativas que puedan ser aplicables a este producto. Por la presente, DUALTRON renuncia expresamente a cualquier garantía, expresa o implícita, en cuanto a la integridad, exactitud y actualidad de dicha información. DUALTRON se reserva el derecho de, pero no está obligado a corregir, implementar y/o actualizar la información. Usted utilizará la información por su cuenta y riesgo. Es su exclusiva responsabilidad conocer y comprender todas las leyes y/o reglamentos, requisitos, prohibiciones, restricciones y/o limitaciones impuestas por la ley, autoridad gubernamental, tribunal u otras partes que puedan aplicarse al uso de este producto.

**Autonomía teórica: Probada con la batería llena, 75 Kg de carga, a 25°C, con una velocidad promedio de 25 Km/h en carretera.

**Autonomía habitual: Probada con la batería llena, 75 Kg de carga, a 25°C, con una velocidad promedio de 50 Km/h en carretera. (Algunos de los factores que afectan a la autonomía son la velocidad, el número de arranques y paradas, la temperatura del ambiente, etc.)

Velocidad máxima: Probada con la batería llena, 75 Kg de carga, 25°C, en una carretera recta y llana, sin viento. (Algunos factores del entorno pueden afectar a la velocidad máxima, como carreteras irregulares, carreteras con curvas, la temperatura, el viento, etc.)



Contenido de la caja

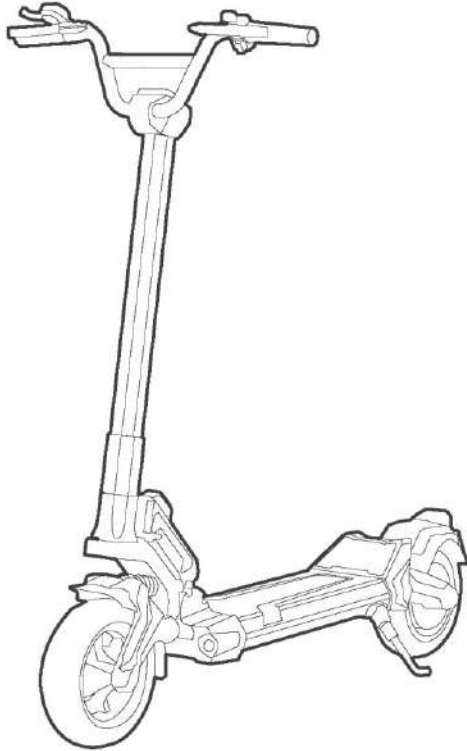

Accesorios



1 x Cargador

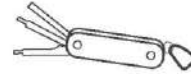

1 x Herramienta



Manual

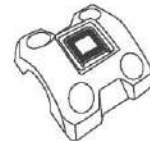

Fijador del manillar

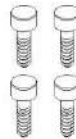

4 tornillos



Ensamblaje

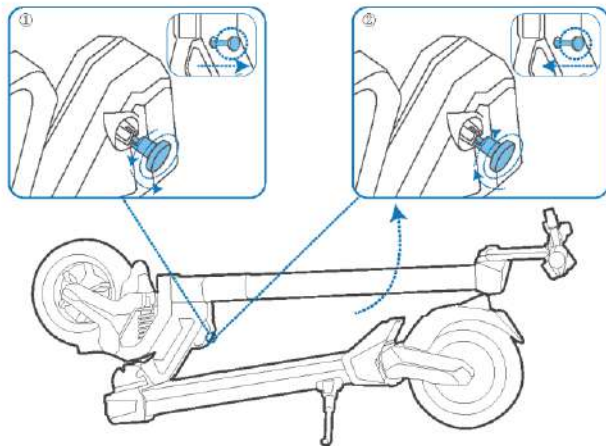

1. Empuje el pasador de seguridad hacia fuera, gírelo un poco para fijarlo; el pasador de seguridad quedará bloqueado y el mango de pliegue funcionará.
2. Levante la tija del manillar y vuelva a insertar el pasador de seguridad para que el sistema de pliegue sea más seguro.

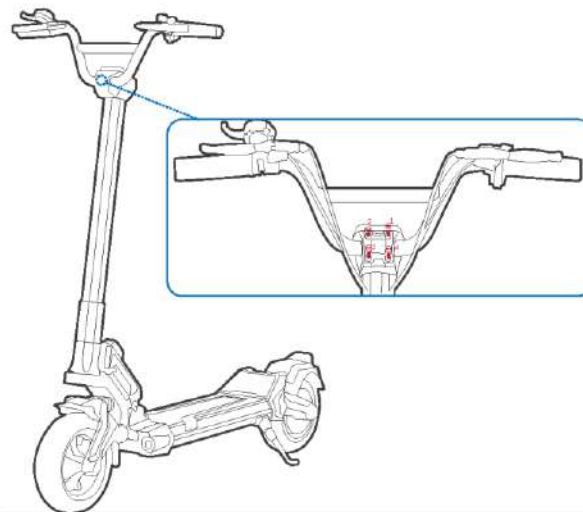

3. Fije el manillar y apriete los 4 tornillos. Primero, apriete los tornillos al 90% en el orden 1-3-2-4 como se muestra en la imagen; luego, termine de apretarlos al 100%.



Conexión Bluetooth

Guía de descarga de la aplicación

Método 1



1. Escanee el código QR para descargar la aplicación.
2. Elija su sistema operativo móvil y regístrese/inicie sesión.

Método 2



1. Busque "DUALTRON" en la tienda y descargue la aplicación; luego, regístrese/inicie sesión.

Pareo por Bluetooth con la aplicación

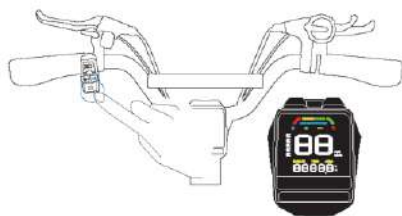

Encienda el patinete eléctrico

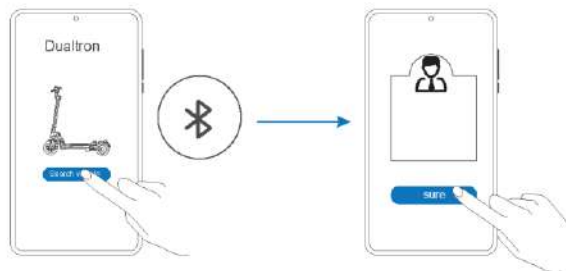

Haga clic en "Buscar un vehículo" y emparejelo con su patinete eléctrico. * El patinete eléctrico estará conectado a la aplicación Dualtron cuando se encienda el símbolo de Bluetooth.

Selecciónelo y regístrese como propietario (nadie más puede conectarse, salvo las personas autorizadas por usted; las autorizaciones se crean en la aplicación).



Cómo utilizar el patinete eléctrico

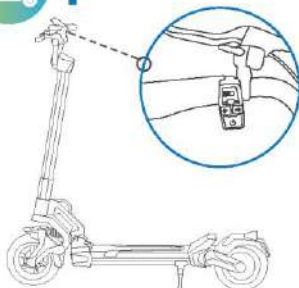

1. Encienda el patinete eléctrico y elija un modo de velocidad. * ¡Por favor, elija un modo de velocidad antes de conducir! Nota: El modo de velocidad puede seleccionarse a través de la aplicación Dualtron.



2. Párese en el reposapiés en un pie y empuje con el otro para empezar a deslizarse. * Asegúrese de haber desactivado el modo SAFE. (El modo SAFE puede configurarse a través de la aplicación Dualtron. Desactive el modo SAFE pulsando la palanca de freno).

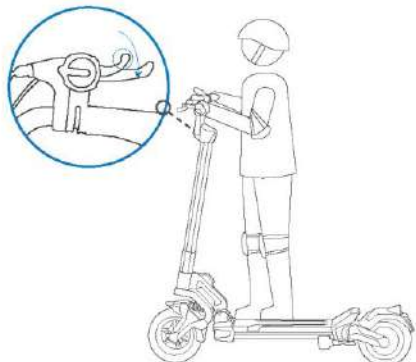

3. Ponga los dos pies en el reposapiés y manténgase firme. Pise el acelerador para acelerar.

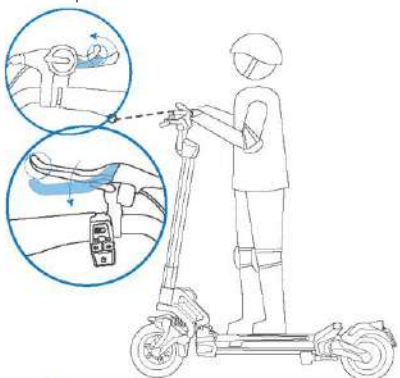

4. Reduzca la velocidad soltando el acelerador y accionando las palancas de freno.

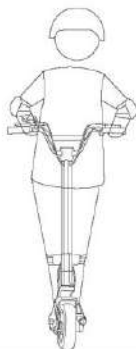

5. Para girar, mueva el cuerpo y gire ligeramente el manillar. Preste atención a las condiciones de la carretera, es necesario que haya suficiente espacio para girar.



En caso de frenazo brusco, pueden producirse graves incidentes o lesiones. Mantenga una velocidad moderada y preste atención a los posibles peligros.



Pliegue

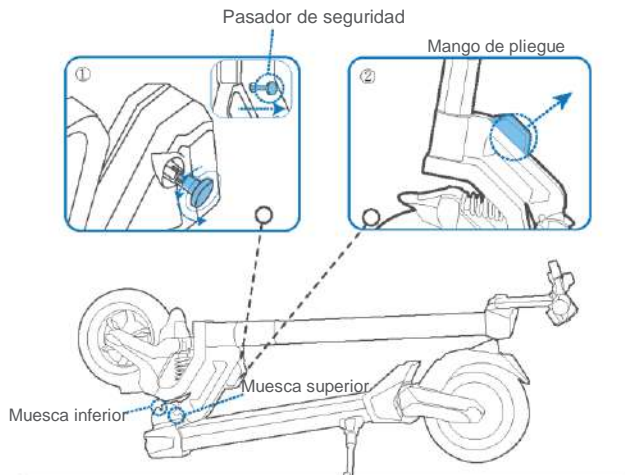

1. Tire del pasador de seguridad hacia fuera, luego gírelo un poco; el pasador se bloqueará y el mango de pliegue funcionará.
2. Tire del mango de pliegue y el pasador de pliegue saldrá de la muesca superior y se deslizará hacia la muesca inferior.

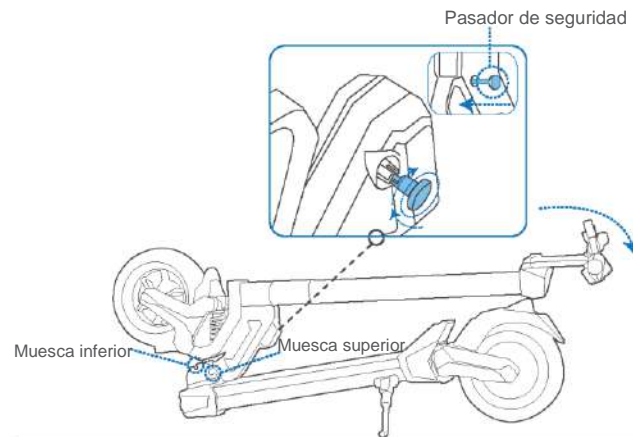

Cuando el pasador de pliegue haya encajado en la muesca inferior, no olvide insertar el pasador para asegurar el sistema de pliegue.

***DUALTORN
T060***

Personal Mobility

PRODUCT MANUAL



Model No. : AD2309



Scan the QR code to download the latest user materials
and obtain the latest updates and safety instructions.

DUALTRON

The dream of electric technology.

Pictures for reference only, subject to our existing products.

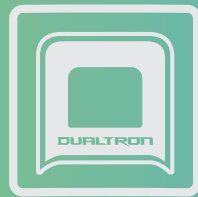



MINIMOTORS

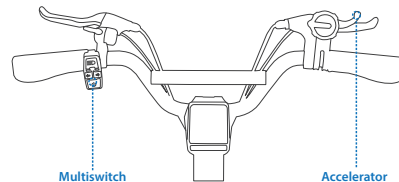
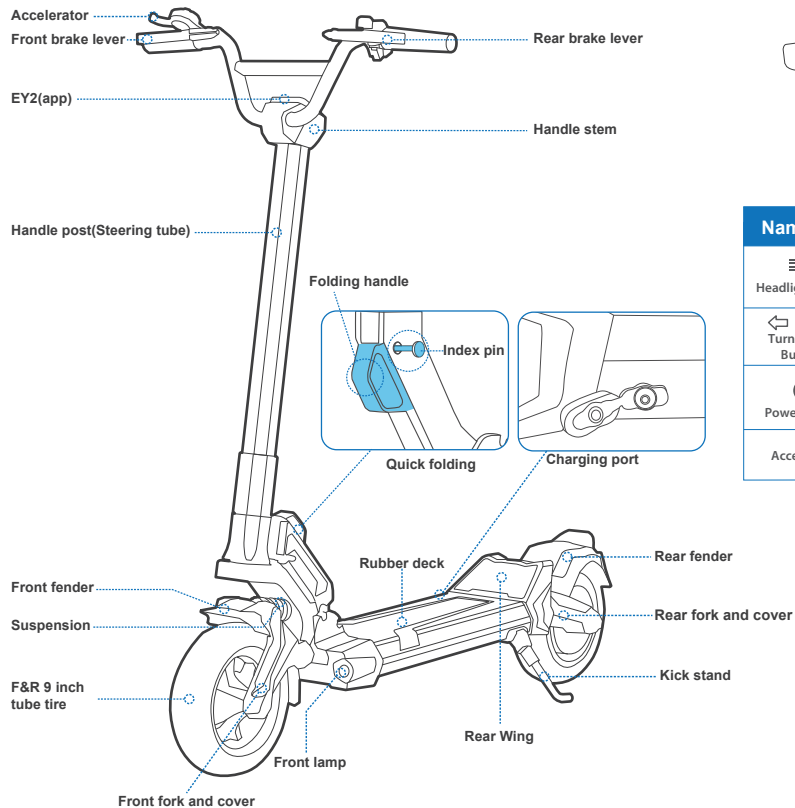

Diagram And Functions



Name	Function	Operation method
 Headlight button	Turn on/off headlight	Press the light button, turn on/off the headlight.
 Turn Signal Button	Turn on/off the left/right signal	Press the left/right arrow of the Turn Signal Button, the left/right turn signal will keep blinking.
 Power Button	Turn on/off power	Press and hold the Power Button to turn on/off the scooter
Accelerator	Speed up	Pull the throttle to accelerate.



Specifications

Item	Parameter					
Product	Model	Dualtron Togo			Dualtron Togo Plus	
Battery	Battery Capacity	36V7.8Ah	36V12Ah	36V15Ah (Samsung)	48V12Ah	48V15Ah (Samsung)
	Range	20km	30km	40km	40km	50km
	Charging Ambient Temperature	0 to 40°C (Battery temperature exceeds 55°C, BMS start protection program.)				
	Battery Management System	Over-heating, short circuit, over-current, over-discharge and over-charge protection				
Rider	Max. load	100kg				
	Recommended Age	14–60 years old				
Display	Type	EY2 display(DUALTRON APP available)				
Motor	Motor Type	BLDC Hub Motor				
	Nominal Power	420W			650W	
Machine	Net Weight	Around 22.8kg	Around 23.5kg	Around 23.7kg	Around 24.3kg	Around 24.4kg
	Max. Slope	Around 26.8% [15°]				
	Drive System	Single motor drive				
	Speed	25km/h				
	Length × Width × Height	1200×600×1130mm				
	Folded: Length × Width × Height	1160×600×400mm				
	Wheelbase	Approx. 940mm				
	Ground Clearance	90mm				
	Traversable Terrain	Asphalt/flat pavement; obstacles < 5 cm; gaps < 5 cm				
	Operating Temperature	-5 to 45°C				
	Storage Temperature	-20 to 50°C				



Specifications

Brake	Type	Dual drum brake	
	Electric Brake	ABS&EBS (Indicating the battery temperature exceeds 55°C,BMS start protection program,ABS/EBS fails.)	
Charger	Input Voltage	100-120V/200-240V~	
	Max. Output Voltage	36V: 41.5V1.5A	48V: 54V1.5A
Tire	Type	9 inch tire 70/50-6.1	
	Tire Pressure	50PSI	
	Material	Rubber	
Suspension	Type	Front&rear spring suspension	

*Disclaimer: this is not a legal opinion or legal advice. The information provided herein (including in the App) is for your convenience and information purpose only. It is not intended to cover every piece of law and/or regulation that may be applicable to this product. DUALTRON explicitly hereby disclaims any and all warranty and/or representation, express or implied, related to completeness, accuracy, up-to-date of such information. DUALTRON reserves the right but not obligation to correct, implement and/or update the information. You shall use the information at your own risk. It is your sole responsibility to learn and understand any and all the law and/or regulation, requirements, prohibition, restriction and/or limitation imposed by either law, government authority, court, private party or the others that may apply to your use of this product.

*Theoretical Range: tested while riding with a full battery, 75 kg load, 25°C, at the speed of 25 km/h on average on pavement.

*Typical Range: tested while riding with a full battery, 75 kg load, 25°C, at the speed of 50 km/h on average on pavement. (Some of the factors that affect range include speed, number of starts and stops, ambient temperature, etc.)

*Max.Speed: tested while riding with a full battery,75kg load,25°C,straight road on flat road with no wind. (Some environmental factors can affect max speed,uneven roads, crooked roads, temperature, wind, etc.)



Packing List

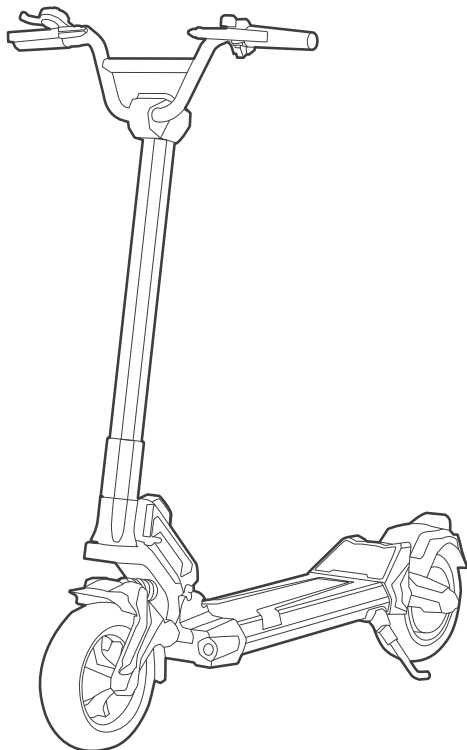

Accessories



Charger x1

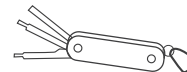

Multitool x 1



Manual

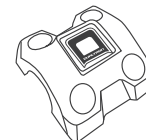

Handle neck upper

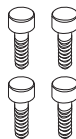

4 screws



Assembly

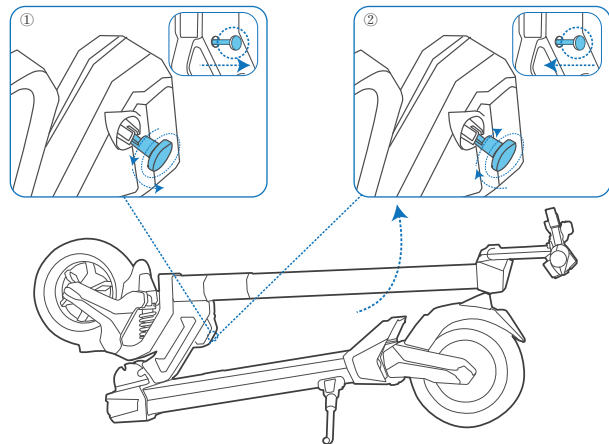

① Pull the index pin outward, then rotate it slightly to ensure a secure fit, the index pin will get stuck and the folding handle will work.

② Raise the steering tube and remember to reinsert the index pin to make this folding system more secure.

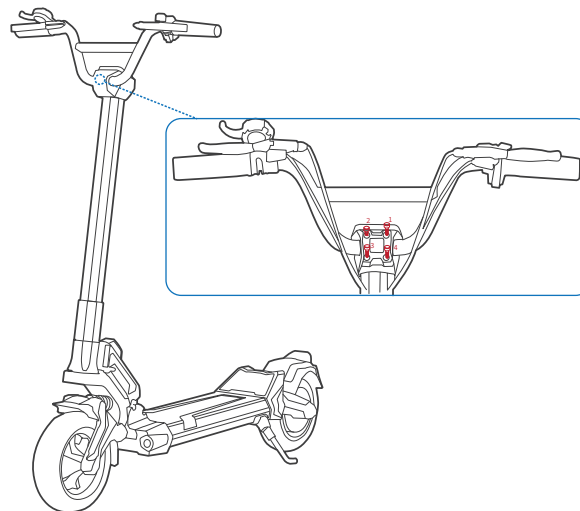

③ Attach the handlebar body and tighten the 4 screws. (When tightening the screw, the first step screw is 90% tight, according to the order 1-3-2-4; the second step all screws are 100% tightened.)



Bluetooth Connection

APP Download Guide

Method 1

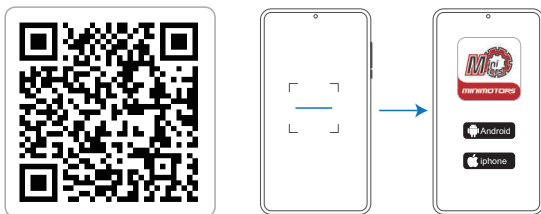

1. Scan the QR code to download the APP.
2. Choose the mobile phone system that suits you to install, and register / log in.

Method 2

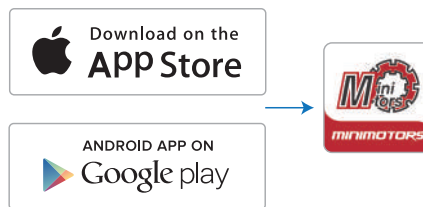

1. Search "DUALTRON" in the application and download it, and register / log in.

Pair the Bluetooth on the APP

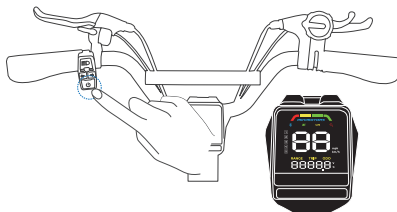

Power on the scooter.

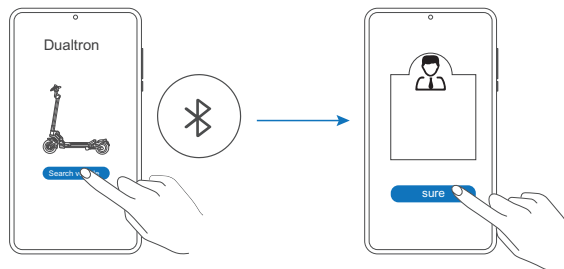

Click "Search vehicle" and pair with your scooter. * The scooter is connected to the Dualtron app when the Bluetooth symbol lights up.

Select "bind as owner".
(No one else can connect, only people authorized by you are allowed to connect. Authorizations are created on the app.)



How to Ride

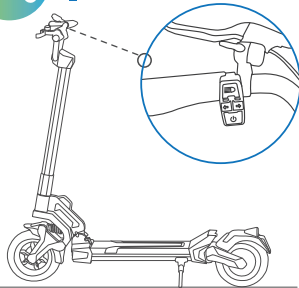

1. Power on the scooter and choose the speed mode. * Please choose the speed mode before riding! Note: Speed mode can be choose via the Dualtron app.



2. Stand on the footboard with one foot and push off with the other foot to start gliding. *Make sure you have disabled SAFE mode. (SAFE mode setting via Dualtron app. Deactivate safe mode by squeezing brake lever.)

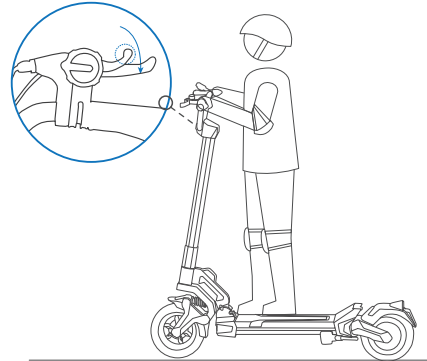

3. Put both feet on the footboard and stand stably. Pull the accelerator to speed up.

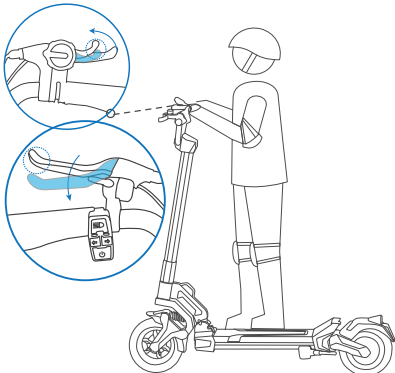

4. Slow down by releasing the accelerator and squeezing brake levers.

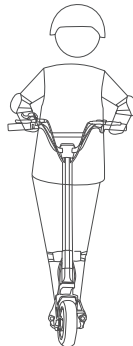

5. To turn, shift your body and turn the handlebar slightly. * Please watch out for road conditions, sufficient turning space is required.

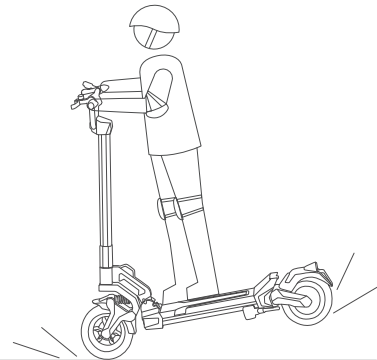

When hard braking, serious danger or injury may occur. Maintain a moderate speed and look out for potential hazards.



Folding

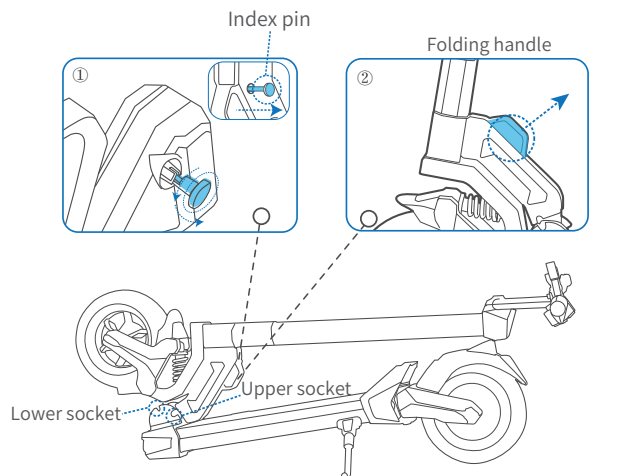

- ① Pull the index pin outward, then rotate it slightly to ensure a secure fit, the index pin will get stuck and the folding handle will work.
- ② Pull the folding handle, folding plunger will come out of the upper socket and slip to lower socket.

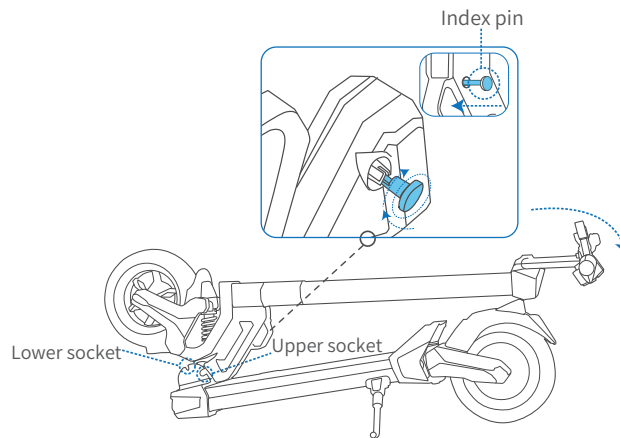

When the folding plunger gets stuck in lower socket and the folding handle resets in the stem headset, please remember to insert the index pin back to fix the folding system.